

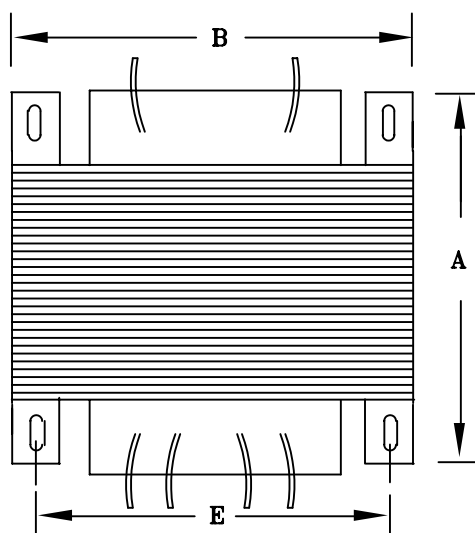

TYPICAL WIRING DIAGRAM

NOTES:

1. ALL UNITS ARE DESIGNED IN ACCORDANCE WITH INDUSTRY STANDARDS.
2. TRANSFORMERS ARE DRY-TYPE, CLASS AA, VENTILATED, OPEN-STYLE ASSEMBLY FOR INDOOR/CONTROL PANEL USE.
3. TRANSFORMER ARE BASE MOUNTED.
4. TRANSFORMERS ARE CONSTRUCTED BASED UPON A 40°C AMBIENT ENVIRONMENT.
5. MAINTAIN 1" CLEARANCE FROM ALL LIVE PARTS.



FRONT VIEW

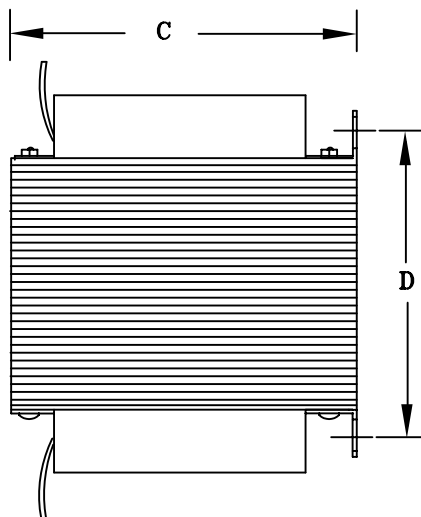

SIDE VIEW

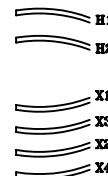

TERMINAL VIEW

APPROXIMATE DIMENSIONS (INCHES)

VA	A	B	C	D	E	F	G	H	J	K	L	STEEL	lbs.	WEATHER SHIELD	TERMINAL TYPE
5000	7.50	9.00	8.25	5.75	7.00	----	----	----	----	----	----	EI-251	80	N/A	LEADS

* ELECTROSTATIC SHIELD GROUNDED TO TRANSFORMER CASE AT FACTORY (IF APPLICABLE)

DRAWINGS
 APPROVAL
 RECORD
 OTHER

PRIMARY VOLTAGE	4800	CUST.	XXXXXXXX		
SECONDARY VOLTAGE	120 / 240	JOB			
TEMPERATURE RISE IN °C	115	CATALOG			
WINDINGS & TERMINALS	<input type="checkbox"/> ALUMINUM <input checked="" type="checkbox"/> COPPER	NOTE	XXXXXXXX		
FREQUENCY	60	BY	ENG. LOG.	TITLE 1-PHASE, HIGH-VOLTAGE CLASS ISOLATION DRY TYPE TRANSFORMER	
TAPS	NONE	DATE			
		REV	MFG. LOG.	DWG. NO.	
		DATE:	DWG. FILE	F414L5000	